Tempo and Loudness Analysis of a Continuous 28-Hour Performance of Erik Satie's Composition "Vexations"

Reinhard Kopiez¹, Marc Bangert¹, Werner Goebel² and Eckart Altenmüller¹

¹Hanover University of Music and Drama, Germany and ²Austrian Research Institute for Artificial Intelligence, Vienna

Abstract

This study extends the perspective of music performance research with an examination of a long-term performance. In a single case study, an uninterrupted recording of Erik Satie's "Vexations" performed by one pianist over almost 28 hours is used as a performance of extreme length to explore new approaches in performance data analysis. The MIDI and acoustical data are analysed with linear and non-linear methods to describe changes in tempo and loudness. Additionally, the performer's changing states of consciousness (alertness, trance, drowsiness) were observed to exert a strong influence on tempo and loudness stability. Tempo and loudness remain stable over the first 14 hours of alertness. A state of trance begins after 15 hours and shows a destabilisation of tempo followed by uncontrolled deviations in loudness. Time series analysis of loudness changes revealed periodicities of about 10 minute lengths. Non-linear analyses of tempo and loudness changes showed a *complex generator pattern* underlying the apparently random fluctuations throughout the performance. This pattern appears most clearly when unfolded in an 18-dimensional embedding space. Measures of fractality and chaotic behavior proved to be dependent on the states of consciousness. Results are discussed in regard to influences of psycho-physiological changes (vigilance) on sensorimotor performance and to the overall stability of an oscillating psycho-motoric system.

"The artist does not have the right to take up the audience's time unnecessarily."

(Satie, 1988, p. 323)

In 1893, the eccentric French composer Erik Satie composed a three-part piece for piano, which he entitled "Vexations." The work is the second movement of *Pages Mystiques*, a collection of three short compositions and consists of a sequence of variations on a bass theme of 18 notes. There are

no metronome indications; however, the piece is to be performed "très lent." "Vexations" remained unknown until it came to the attention of the American composer John Cage, doing research in France in 1949 and was first published in the same year (see Bryars, 1983). The most remarkable feature of "Vexations" was Satie's enigmatic instruction at the score's top: "To play this motif 840 times in succession, it would be advisable to prepare oneself beforehand, in the deepest silence, by serious immobilities."

There is no proof of a performance during Satie's lifetime and it is not established whether an actual performance of "Vexations" was intended by Satie at all. For example, Wehmeyer (1998, p. 21) argues that the piece is a parody on Satie's lessons in composition as a student at the Paris Conservatoire. One of the daily exercises at the Conservatoire was the harmonisation of a given bass melody in close and extended position. This compositional technique can be identified in "Vexations" in its sequence of a theme, followed by two variations in double counterpoint (see Fig. 1).

Orledge (1992, p. 143) argues that "Vexations" is one of Satie's "numerous ways to cheat the passage of time" through an "absence of any climax or movement towards a goal." This impression is achieved through the compositional means of a sequence of unresolved diminished and augmented chords. The composition joins the tradition of musical works of extreme duration in European avantgarde music, such as Morton Feldman's *Second string quartet* (with a duration of about 5 hours) and John Cage's *ORGAN²/ASLSP* (ASLSP stands for "As slow as possible"). In a recently commenced undertaking, a performance of Cage's *ORGAN²/ASLSP* is planned to last at least 639 years, to be played on the organ of the Burchardi church in Halberstadt, Germany (see Cage, 2001). This realisation began on 5 September 2001 with a one and a half year rest. The first three notes will sound on

Accepted: 1 April, 2003

Correspondence: Reinhard Kopiez, Hanover University of Music and Drama, Emmichplatz 1, 30175 Hannover, Germany. E-mail: kopiez@hmt-hannover.de

Theme



Variation 1

Musical notation for Variation 1 of Erik Satie's "Vexations". It is a two-staff piece in treble and bass clefs, 3/4 time, with a key signature of one flat. The bass staff contains the same melody as the Theme. The treble staff features a complex, dense texture of chords and intervals, primarily consisting of eighth and quarter notes.

Variation 2

Musical notation for Variation 2 of Erik Satie's "Vexations". It is a two-staff piece in treble and bass clefs, 3/4 time, with a key signature of one flat. The bass staff contains the same melody as the Theme. The treble staff features a complex, dense texture of chords and intervals, primarily consisting of eighth and quarter notes, with some sixteenth-note patterns.

Fig. 1. Erik Satie's composition "Vexations" comprises one theme and two variations. One rendition of the score comprises: Theme – Variation 1 – Theme – Variation 2. It has to be repeated 840 times. Tempo: "très lent."

5 February 2003 and weights will secure the last combination of notes played until the point when the next event is to be commenced.

The first public and complete performance of Satie's "Vexations" was organised by John Cage and took place in New York in 1963 with a total performance duration of 18.40 hours. However, Cage shared the task with 9 other pianists (for a short report see Cage, 1980). As Bryars (1983) discusses in his report on 23 "Vexations" performances between 1958 and 1977, two points remain contentious: firstly, the question of team vs. solo performance, and, secondly, the question of tempo. To summarise, there is no decisive argument in favor of a team performance against a solo one, and the tempo indication "très lent" can be related to a metronome marking only by comparing the tempo character of "Vexations" to other similar compositions by Satie. Ultimately, the chosen tempo is decided by the player and thus, the total performance duration of all 840 renditions varied between 5.48 and 24.46 hours (Bryars, 1983). In a recent publication, deeper insights into the pianist's coping strategies for the specific demands of a performance are investi-

gated in an extensive interview with the solo performer of "Vexations" by Kopiez (1998).

The interest in the field of music psychology in "Vexations" can be traced back to 1974. At this time Michon (1974) was interested in whether note durations in a very slow tempo such as in "Vexations" show a higher deviation in interonset intervals (IOIs) than in medium and fast tempi. With regard to the extremely long performance duration of "Vexations," the author examines how tempo stability is controlled during the course of a performance. He predicted that an inner clock model is insufficient as an explanation, due to the consideration of only the latest interonset interval. As an alternative to serial models of tempo control, Michon suggests a hierarchical model, which considers the control of durations on five rhythmic layers, from a beat level of single note events up to the length of the entire theme. To test his predictions of a multi-layer tempo control system, he recorded 19 hours of "Vexations" on several tapes performed by four pianists. Results of factor analysis of IOI deviations from grand averaged deviations of IOIs revealed five factors. The author interprets this finding as a confirmation of the predicted

hierarchical tempo control system. Despite several technical insufficiencies, Michon's study marks the beginning of research interest in long-term performances and remains a pioneering work.

The second approach was realised by Clarke (1982) who analysed (a) the relationship between tempo and grouping of note events and (b) the relationship between tempo and overall tempo drifts. His analyses were based on one-hour recordings of "Vexations" effected through a grand piano equipped with photocells under each key attached to a computer, measuring note onset, offset and hammer velocity (loudness). Two subjects were instructed to vary tempo within given limits and to perform repeatedly about one hour of "Vexations." Firstly, the performances showed an overall tempo drift effect: faster tempi became progressively slower while slower tempi became progressively faster. Secondly, analyses of quarter and eighth note duration distributions showed that tempo control increases when tempo increases. Thirdly, the number of note groups increased with slower tempo. This finding is interpreted as a tendency for Gestalt dissociation when group duration exceeds certain limits. Thus, their study asserts that there does indeed exist a correlation between tempo and note grouping.

The rationale of the present study

Although performance research has made significant progress in the last decade, there is a lack of investigations, which consider musical performance not only from a local (note to note) but from a global perspective (e.g., the long-term performances of an entire movement). For example, as Langner and Kopiez (1996) show, large-scale shaping of tempo within a time frame of several minutes is characteristic of expert performance. From a global perspective, the composition "Vexations" offers a great challenge to performance research due to its quasi "infinite" duration. The precondition for an investigation of expressive deviations within large time frames is an uninterrupted performance by one performer and an uninterrupted recording. The first aim and main focus of the study is a global examination of tempo and loudness in that performance.

The second aim is to take advantage of the highly repetitive nature of "Vexations" in an examination of changes on a local level and an analysis of note durations and note loudness systematically over time. In other words: are the same note events always performed in an unchanged manner? It can be hypothesised that systematic variation of expressive parameters will determine the organisation of the entire performance, such as the segmentation and hierarchical grouping of musical events into larger units.

The third aim of the study is to develop and explore adequate methods for long-term performance analysis. Up until now there has been a significant lack of methods for the study of entire performances with time-frames of more than a few minutes. The development of adequate methods for the analysis of an extreme example of musical long-term per-

formance is intended by this paper. Within a broader research framework this aim is of importance for the following reasons: firstly, up until now, musical performances with a duration of one or two hours remained unconsidered; secondly, analysis of long-term performances will allow conclusions to be made about the general behavior and mechanisms of motor stability of the performer as an oscillating biological system; thirdly, from the observation of the performer's efficiency we hope to draw conclusions about the psycho-motor system's nature under extreme conditions. Although musical repertoire for solo instrument does not contain many works with a duration of more than one hour, we hope that findings will be relevant for the understanding of other performers, such as conductors who are also confronted with performances of extreme length. For example, operas often have a performance duration of between one and five hours (e.g., Wagner's *The Mastersingers of Nuremberg*).

To summarise, this paper is an explorative single-case study that intends to find means for an adequate analysis of an unusual composition. Our focus, which should be the aim of all performance research is to gain more insight into the complex psycho-physiological system of the musical performer.

Method

Participant

The composition was performed by a 40-year-old professional pianist, who had previously performed this piece.

Material

The performance was played on a grand piano (Yamaha DS 6 Pro Disklavier) with a built-in MIDI interface. MIDI and acoustical data were recorded onto hard disc – the audio recording in CD quality (16 bit, 44.1 kHz sampling rate) – using professional microphones (Neumann KM 84), a mixing console (Behringer MX 802A) and two PCs (Pentium III, 550 MHz) running a LINUX operating system. A sound level limiter (Behringer Composer Pro) between mixing console and PC avoided digital clipping in the acoustical recording. To manage the immense amount of audio data, a researcher-developed software was used to segment the data stream into separate smaller files of 100 MB each. Additionally, the audio data was backed up on two overlapping DAT tapes (Tascam DA 302). The entire recording procedure is displayed in Figure 2.

Recording procedure

The recordings took place in a concert hall in Dresden, Germany. The entire performance of Erik Satie's "Vexations" commenced at 5 p.m. and ended at 8.47 p.m. the following evening. An initial tempo of 52 beats per minute (bpm, eighth notes) was chosen by the performer and was established by

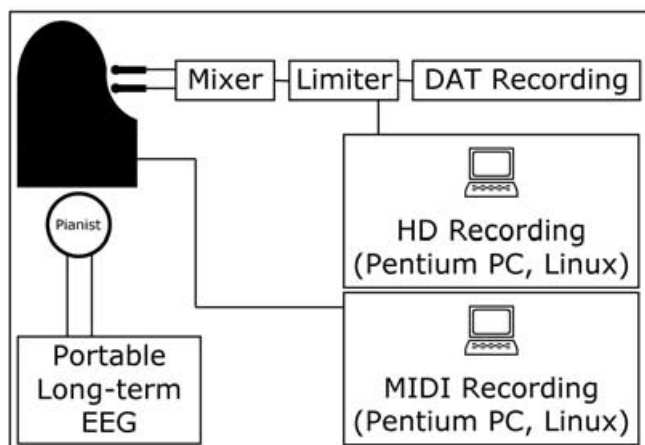

Fig. 2. The entire recording procedure including long-term recording of brain activity, MIDI and audio recording. To avoid digital clipping, a limiter was used in the acoustical recording. However, the limiting threshold was set to the immediate vicinity of the maximum digital recording level.

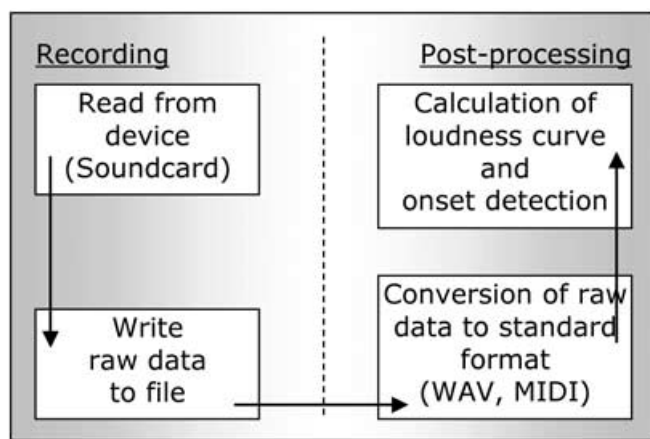

Fig. 3. Basic post-processing steps of raw data recording for the analysis of timing and loudness.

use of a light-emitting metronome. No specific instructions were given to the performer. Total recording time was 27 hours and 47 minutes (27.78 hours). During the “Theme” section which is played with one hand, the performer could take minor refreshments, presented on a small table beside the pianist.

Basic analytical method

The basic analytical approach to the raw data for the analysis of timing and loudness is displayed in Figure 3. In a first step, audio raw data was converted to standard WAV format. In a second step, the loudness curve of the entire performance was calculated in sone by use of a custom-made software, based on the psychoacoustic model by Zwicker and Fastl (1999). Time resolution of the loudness curve was 10ms. For a detailed description of the loudness analysis

procedure see Langner, Kopiez, and Feiten (1998) and Langner (2002). In a third step, the loudness curve was segmented into sections of 30 seconds each for the determination of note onsets. These small sections were loaded into a perceptually-based, custom-made onset detection program. The moment of onset and the corresponding sone-value were stored into a text file. Errors in onset detection were corrected manually. The onset detection resulted in a two-column text file containing loudness values in the first column and onsets marked by their loudness value (in sone) in the second, each line representing a time interval of 10 ms. This file contained 9,677,918 lines of text with an amount of more than 170 MB.

From the onset text file, an interonset distribution was calculated. In order to derive tempo values in bpm, we should know how long a given performed note should have been according to the score. A score-to-performance matching procedure was not applied, since it would have been too complex with this enormous amount of data (all existing procedures still include manual correction), and would have totally failed in the trance section, where the pianist played anything but correct notes for some time. A simple straightforward procedure was used instead. “Vexations” contains only three different note values: eighth notes, quarter notes, and dotted quarter notes. All IOIs shorter than 1.58 s were treated as eighth notes, above that and below 2.9 s as quarter notes, and above 2.9 s as dotted quarter notes. The values represent the minima between the three peaks of the IOI distribution. The width of the bins is 59.4 ms (see Fig. 4).

This procedure introduced some noise into the tempo data, which could have been avoided by meticulous data correction, but it produced sufficient results for the present purpose. Not all tempo peaks do represent sudden accelerations, but could result from notes, played accidentally by the performer. For example, an additional note between two eighth notes results in two tempo values approximately twice as large as they should be. To avoid this data noise, the tempo curve was smoothed using a rectangular window with 35 data points on either side of the current value, corresponding to the 71 tempo values within each of the 840 renditions of the score.

Calculation of performance trajectories

Background

As Langner and Goebel (2002) claim, there is a mismatch between human perception of expressive music performance and the usual methods in performance research in two points: (a) performance parameters are not perceived as separate streams of information (e.g., timing and loudness) and (b) changes in loudness and tempo are perceptually integrated over time in human perception so that sudden and very local changes in tempo or loudness do not correspond to the impression of an accelerando or a crescendo. The perceptual evaluation of this two-dimensional display has yet to be validated by listening tests. Thus, a method for performance

analysis that considers human perception should display the changes in tempo and loudness simultaneously over time. Additionally, an option for averaging data with adjustable time-frames (according to musical units such as one measure) should be included. Such an integrated approach would result in a graph (a so-called "trajectory") which displays the course of tempo and loudness simultaneously over time. Samples for the application of this method to the analysis of a Chopin Etude are presented in Langner and Goebel (2002; in press).

Analytical method

Tempo data was extracted from the two-column interonset file. The loudness information (perceptual measurement of loudness in sone according to Zwicker & Fastl, 1999) was derived from the corresponding acoustical recording of "Vexations." The smoothed tempo and loudness data was resampled to a time frame of 0.25 seconds and displayed in a two-dimensional space of tempo and loudness.

Time series analyses of note durations and loudness

A 28-hour uninterrupted performance of a complex repetitive motor pattern with a cycle duration of approximately 2 minutes represents an ideal data source for linear as well as nonlinear analytical computations. The complete recording may exhibit either transient properties, periodic properties, quasi-periodic properties, or properties of deterministic chaos. Of importance to this study is the question of whether distinctive features within the performance determine subsequent or future structures. The periodic structure of the piece itself would – if performed by a machine – produce a perfectly periodic time series. If performed by a human being, one would expect some sort of quasi-periodic deviation. However, this quasi-periodicity might be superimposed by deterministic processes on a larger time scale. Therefore, further analyses are applicable to clarify whether the time course of the performance is non-deterministic (i.e., noise), deterministic with a convergent, stable behaviour, or even deterministic with "unpredictable," divergent behavior – namely, chaos.

Analytical method

The linear and non-linear time series analyses were calculated with the software bundle TISEAN (Hegger, Kantz, & Schreiber, 1999) and plotted using MATLAB™ (Mathworks). During the performance a spectator recorded a protocol of events. Additionally, the pianist recorded a retrospective protocol of events after the performance. According to this protocol we divided sections of the performance into three different states and three data subsets were extracted: alertness (0.10–2.10 hr), trance (14.10–19.09 hr) and drowsiness (19.20–21.00 hr). Behavioural and EEG data of all three states were compared (for details see

Kohlmetz, Kopiez, & Altenmüller, 2003). Trance is often referred to as a distinct level of consciousness, characterised by a restful yet fully alert state of mind with a heightened perception. Thus, in trance one may experience conflicting perceptions and time shortening (Travis & Pearson, 1999). The characteristic features of this meditative state, being the loss of the external frameworks (time, space, and bodily sensation) and mental content (inner and outer perception), are often interpreted as the result of a dominant right hemisphere. In practitioners of transcendental meditation, EEG recordings showed a distinct pattern of electrocortical activity (Dunn, Hartigan, & Mikulas, 1999; West, 1980), including synchronisation of the alpha spectrum (Jevning, Wallace, & Beidebach, 1992) and an increase in the relative power of theta 2 (6.0–7.5 Hz) and alpha 1 (8.0–10.0 Hz) activity (Alexander, Davies, & Dixon, 1990; Mason et al., 1997). In accordance with these findings, the significant increase of alpha 1 activity was also used as a physiological indicator of the state of trance in our study. Within the trance state, there were two "blackout" episodes during which the performance was completely suspended for about a minute each (protocol: "microsleep"). These short blackout episodes were included in the analysis as well but yielded no consistent results in terms of the target parameters and are therefore not presented here.

Linear time series analyses of note durations and loudness

Autocorrelation

The autocorrelation function gives a measure of how far one has to shift a given signal, compared to a copy of itself, to make the time signals appear similar again. In other words, time lags where the autocorrelation value is high, point to putative periodicities within the signal.

The series of transient keystrokes, each regarded as a singular event, resemble the succession of so-called 'action potentials' generated by nerve fibers. Neuroscientists customarily analyse the series of onsets of action potentials only. These series' are known as "spike trains." In our analysis, spike train temporal autocorrelations were computed for a modified time series, where only the timepoint of detected note onsets were kept and all intermittent data (sone-values) were set to zero. The resulting data set can be considered a linear sum of delta pulses at the times of the note onsets. Information about the performance loudness is still present in the data, as the delta pulses have the sone amplitude of the respective onset.

Nonlinear time series analyses of note durations and loudness

The use of non-linear methods was motivated through the immense amount of performance data that had to be reduced without the risk of a loss of information buried in the

complex data. The application of tools from non-linear time series analysis seemed to be the most promising way to fulfill (a) the condition of data reduction and (b) of information maintenance.

Multidimensional embedding of the time series

In the first step in non-linear analysis approaches, it is a common practice to “embed” a given time series. This means, one has to build up an appropriate multidimensional space (m dimensions), in which each dimension contains a measured value of the time series temporally separated from each other by a specific amount of time (“delay” d). For example, let us consider a three-dimensional embedding space ($m = 3$) with a delay of $d = 1$ sec. For each sample of the time series, one plots the value of a sample on the first axis, the value of a sample one second later on the second axis, and the value of a sample two seconds later on the third axis. Thus, each point of the resulting pattern (or trajectory) contains information not only about a given sample, but also about the future development of the time series.

It is obvious that the shape of the resulting trajectory is very sensitive to the choice of the embedding dimension and delay. An appropriate embedding dimension can be estimated by plotting the “correlation dimension” for increasing values of m (see the section “correlation dimension” below). This is an estimator of the embedding dimension.

With respect to the time axis of the non-linear embedding procedure, two approaches were tested. Firstly, the complete time series with 100 samples per second was processed. Secondly, as the acoustical data between two keystrokes cannot be controlled by the pianist, a relative time measure was introduced with each note onset being a distinct timestep, regardless of whether the played note was of eighth, quarter, or dotted quarter note length. Thus, the embedding procedure could take the predictability of the loudness/interonset-interval of a specific tone into account, depending on the history of the preceding tones. The second approach proved to provide more robust results, which will be presented later in this paper.

We estimated the maximum Lyapunov coefficient and the correlation dimension. For the embedding of the time series, various parameters were tested in order to determine the optimum embedding situation. The delay d with the value of 1 was chosen for the embedding, the Theiler window w was set to 100 in order to exclude repetitions of one cycle of the Satie piece (1 cycle = 72 notes), and the embedding dimension was varied from 1 to 72.

Generalized dimensions and self-similarity

The “perpetually” repetitive character of the piece offers an opportunity to apply the tool of generalised dimensions to the performance data set. A “trajectory” of virtually any parameter recorded throughout the performance of this particular piece is expected to re-enter similar recurring points of

the piece again and again. But is the parameter constant at the instance of each recurrence? Is there, in addition to systematic global shifts, an underlying system predicting a parameter in the following keystroke, phrase, or whole cycle, on the basis of one or several of the preceding keystrokes, phrases, or cycles? Usually (with dissipative dynamical systems), trajectories are confined to lower dimensional subsets of the phase space. This simply means that the trajectory is an object with fewer dimensions than we have to use to “embed” it (not unlike the example that a wildly twisted wire is embedded in 3-dimensional space but has not more than one dimension inherently). These subsets can be extremely complicated, and they frequently possess a fractal structure, meaning that they are self-similar in a nontrivial way. Generalised dimensions are one class of quantity which characterise this fractality. The Hausdorff dimension, from the mathematical point of view, is the most natural concept to characterise fractal sets (Eckmann & Ruelle, 1985), whereby the information dimension takes the relative visitation frequencies into account and is therefore more attractive for physical systems. Ultimately, other similar concepts, like the correlation dimension, are more useful for the characterisation of measured data. Dimensions are invariant under smooth transformations and are thus again computable in time delay embedding spaces.

The correlation dimension was chosen to analyse the data in “Vexations.” Generalised dimensions are promising for this kind of explorative approach because the ever-repeating cycle of the piece suggests a self-similar or fractal structure of the performance, and because every order of magnification from local to global features (single note, phrase, cycle, entire piece) remains included as long as there is no reason to exclude any possibility in the first place.

Correlation dimension

Correlation dimension is a measure of the structural complexity of an attractor. Roughly speaking, the idea behind certain quantifiers of dimensions is that the weight $p(\epsilon)$ of a typical ϵ -ball covering part of the invariant set scales with its radius like $p(\epsilon) \approx \epsilon^D$ (where the value for D depends also on the precise way one defines the weight). Using the square of the probability p_i to find a point of the set inside the ball, the dimension is called the “correlation dimension” D_2 , which is computed most efficiently by the correlation sum (Grassberger & Procaccia, 1983):

$$C(m, \epsilon) = \frac{1}{N_{pairs}} \sum_{j=m}^N \sum_{k=j-w}^N \Theta(\epsilon - |s_j - s_k|) \quad (1)$$

where s_i are m -dimensional delay vectors, $N_{pairs} = (N - m - 1)(N - m - w + 1)/2$ the number of pairs of points covered by the sums, Θ is the Heaviside step function, and w is the so-called Theiler window (Theiler, 1990).

If the correlation dimension converges with increasing embedding dimension m to a fixed value, one can consider

the embedding dimension at which saturation is reached. This is suitable for complete embedding and unfolding of a possibly underlying attractor by which the dynamics of the system can be described. The m value for which the curves converge is an estimator of the embedding dimension. If there is no underlying deterministic process but noise only, the respective curves will not saturate and will not gather around the correlation dimension.

Lyapunov exponents

Chaos arises from the exponential growth of infinitesimal perturbations, together with global folding mechanisms to guarantee boundedness of the solutions. This exponential instability is characterised by the spectrum of Lyapunov exponents (Eckmann & Ruelle, 1985). If one assumes a local decomposition of the phase space into directions with different stretching or contraction rates, then the spectrum of exponents is the proper average of these local rates over the whole invariant set, and thus consists of as many exponents as there are space directions.

The maximal exponent

The maximal Lyapunov exponent can be determined without the explicit construction of a model for the time series. Since the convergence of the correlation dimension with increasing embedding dimension has been previously checked (see the "correlation dimension" section), we applied an embedding dimension of $m = 18$ with a delay of $d = 1$ to compute

$$S(\varepsilon, m, t) = \left\langle \ln \left(\frac{1}{|U_n|} \sum_{s_n, s'_n \in U_n} |S_{n+t} - S_{n'+t}| \right) \right\rangle_n \quad (2)$$

We used the very similar algorithm of Rosenstein, Collins, and De Luca (1993) where only the closest neighbor is followed for each reference point. Also, the Euclidean norm is used. If $S(\varepsilon, m, t)$ exhibits a linear increase with identical slope for a reasonably large m (in this case, $m = 18$), then this slope can be taken as an estimate of the maximal exponent λ . For the IOI data, no satisfying linear slope for $S(\varepsilon, m, t)$ was detected in any of the conditions; alert, drowsy, or trance.

Results

Analysis of tempo

From the onset text file, an interonset distribution was calculated (see Fig. 4). We should bear in mind that tempo peaks artefacts are caused by the straight-forward tempo analysis. Analysis of overall interonset durations by categories of note lengths (see Fig. 4) revealed a surprisingly high stability: mean note duration for all eighth notes (IOIs < 1.58 s) was 1.0 s (SD = 0.1 s), mean note duration for all quarter notes (IOIs > 1.59 and < 2.9 s) was 2.2 s (SD = 0.2 s) and

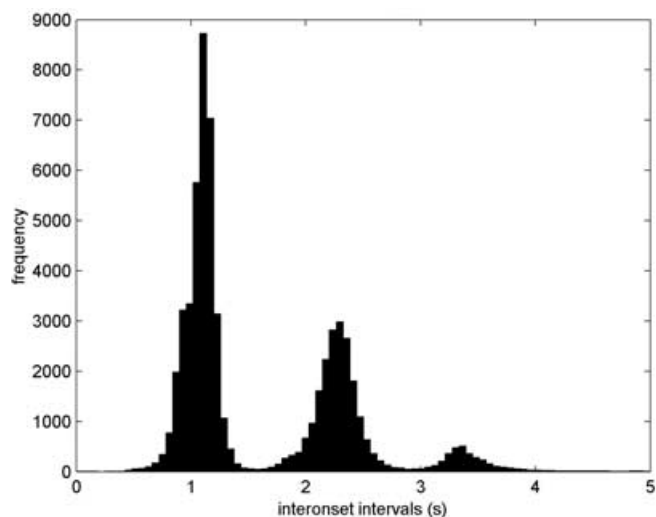

Fig. 4. Overall distribution of IOIs over the entire performance duration of about 28 hours. Left peak = quarter notes, middle = eighth notes, right = dotted quarter notes (last syncopated note of staff). (Note: about 20 outliers are located between IOIs from 5 to 30 seconds which cannot be displayed here due to the chosen resolution of the x-axis.)

mean note duration for all dotted quarter notes (IOIs > 2.9 s) was 3.6 s (SD = 1.2 s). This means that eighth notes varied with 10%, quarter notes with 9% and dotted quarter notes with 33% of their value. The higher variability of the dotted note might be due to the fact that it is the final note of the theme.

From this, the development of tempo over the entire performance duration of 27.78 hours was analysed. As shown in Figure 5, the mean tempo remained surprisingly stable over the first 15 hours of performance although the light-emitting metronome was only used for the initial fixing of tempo (mean tempo for 00.00–14.00 hours = 54.7 bpm, SD = 5.6 bpm). The mean tempo curve in Figure 5 was calculated by averaging the current tempo over 35 data points on either side of the current IOI-value within a rectangular window (corresponding to 71 values within each of the 840 renditions of the score). No general trend in tempo change could be observed in this first section. Commencing with the transition to the trance section at $t = 14.00$ hours, a slight increase in tempo and tempo instability can be observed (mean tempo 14.00–16.08 hours = 58.5 bpm, SD = 7.7). However, according to the different states of consciousness as reported in the pianist's retrospective protocol (see Kohlmetz et al., in press), we have to bear in mind that the pianist was in a deep trance between 14.10 and 19.09 hours. This state of consciousness seems to have a strong influence on the average tempo stability (mean tempo 14.00–19.09 hours = 58.7 bpm, SD = 10.3 bpm). After the end of trance (after about 19.00 hours) the initial tempo stability could not be re-established and shows higher deviations compared to the beginning (mean tempo from 19.09 hours until the end = 54.2 bpm, SD = 7.1 bpm).

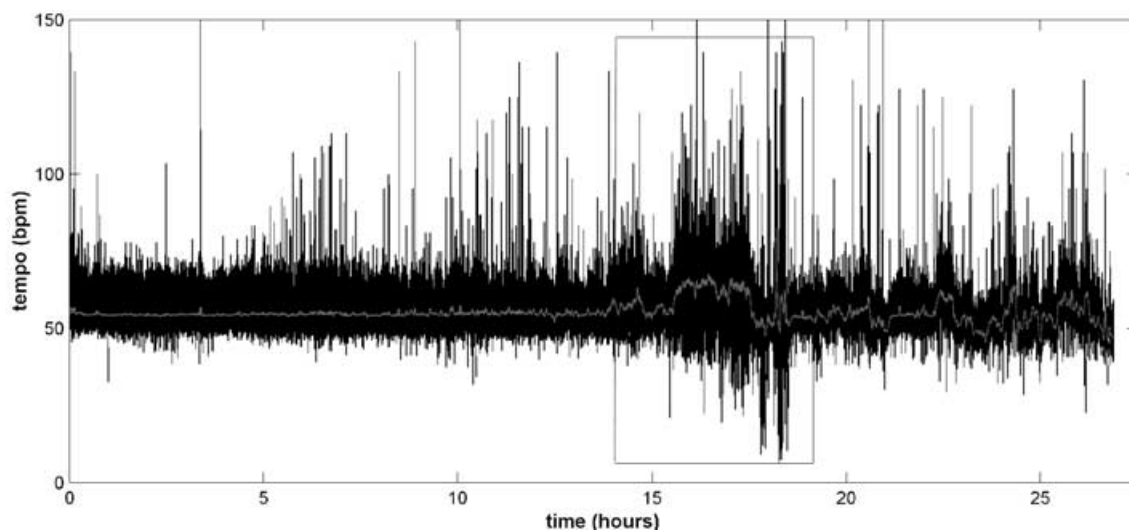

Fig. 5. Development of tempo changes over the entire performance duration of about 28 hours. The bright line represents the smoothed mean tempo curve. The box indicates the state of trance.

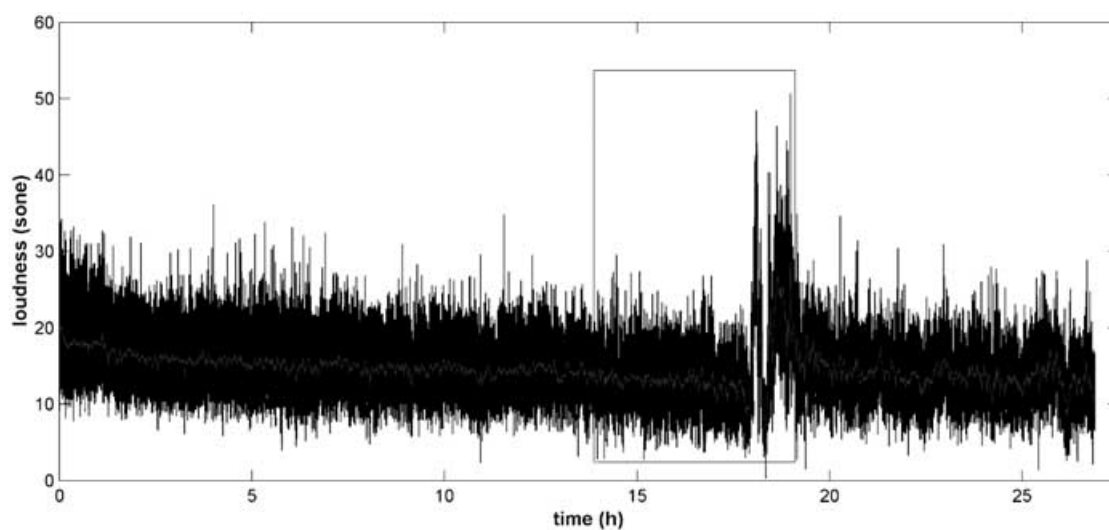

Fig. 6. Development of changes in loudness over the entire performance duration of about 28 hours. The bright line represents the smoothed mean loudness curve. Box indicates state of trance.

Analysis of loudness

The most obvious result of the analysis of the overall loudness curve (see Fig. 6, smoothed curve calculated as in Fig. 5) is the segmentation of the loudness curve into three parts: a first part which is characterised by an overall and continuous decline of loudness over roughly the first 18 hours with a mean loudness of 14.7 sone, a second part which is characterised by a higher degree of instability and more sudden increase in loudness (mean: 18.97 sone), and a third part that shows more dynamic instability than the first part and less extreme changes than the second (mean: 13.7 sone; for statistical details see Table 1). We have to remember that the second part corresponds to the end of the trance section (about 14.00–19.00 hours). However, as the averaged loud-

Table 1. Mean loudness values (and their standard deviations) in sone during three different states of consciousness.

	0.00–17.80 hrs (alert)	17.80 hrs–19.30 hrs (trance)	19.30 hrs–end (drowsy)
Mean	14.7	18.97	13.7
SD	3.6	7.7	3.4

ness curve shows, the beginning of trance at 14.00 hours does not seem to influence the stability of the general decline. The sudden loudness burst at 19.00 hours corresponds to the end of the trance section. Surprisingly, the beginning of tempo

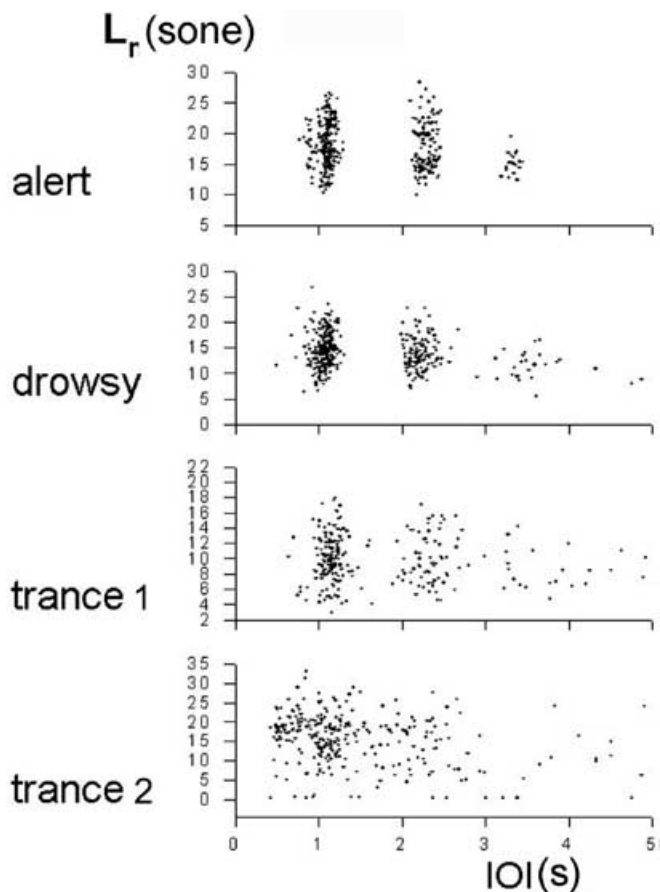

Fig. 7. Loudness of an onset (in sone, y-axis) versus the performed interonset interval (IOI in seconds, x-axis), for each single note (keystroke) during 10-minute excerpts from different stages of the performance. Displayed are alertness (top), drowsiness (mid), and two excerpts from the trance episode (bottom panels). For the trance stages the data displayed in the upper graph was selected from the state in which loudness minimum was reached (cf. right half of the respective box in Fig. 6), while those displayed in the lower graph was characterised by greater psychomotoric instability of performance (final stage of the trance, compare the tempo variability in Figs. 5 and 8).

instability at 14.00 hours (see Fig. 5) does not coincide with the onset of dynamic instability at 18.00 hours. Although the increasing instability in tempo and loudness seem to be two independent processes, we can observe a synchronisation between tempo and loudness instability at about 19.00 hours after the end of the trance section.

Analysis of loudness changes on a more local level revealed an interesting pattern. Figure 7 displays the loudness of notes in three duration categories (eighth notes, quarter notes, dotted quarter notes) over the three states of consciousness. The idea, not unlike the tempo-loudness trajectory of Figure 8, is to define the x and y coordinates of a single keystroke by two putatively independent parameters of musical behavior. The figure shows that performed loudness is independent of the note duration, as the vertical extension

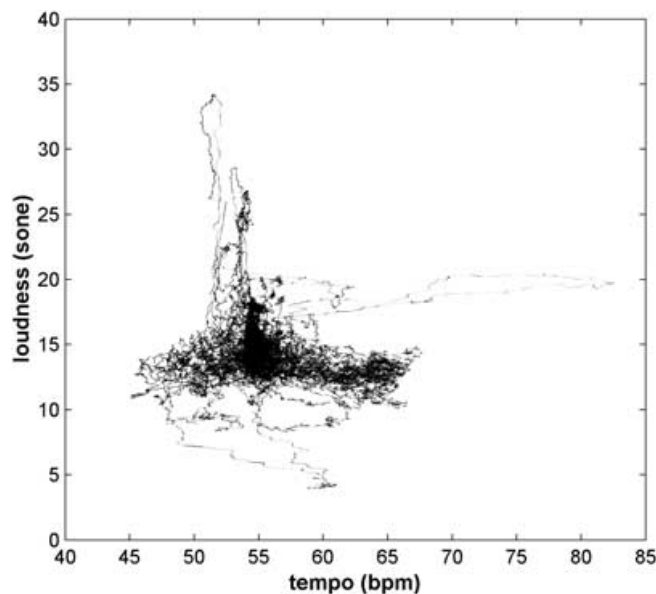

Fig. 8. Twenty-eight hours tempo-loudness trajectory of Satie's "Vexations" (x-axis: tempo in bpm, y-axis: loudness in sone). The individual points are 250 ms apart.

of the dot clouds does not correlate with duration. However, during the performer's different states of consciousness, the elliptical shape of the loudness distribution increasingly disintegrates from alertness to trance. The distortion of the shape also means that timing becomes progressively more unstable while the performed loudness remains controlled. This homogeneity of disintegration of tempo control affects all note durations and is the most striking feature of the trance section.

The performance as tempo-loudness trajectory

Figure 8 shows the development of loudness and tempo over the entire performance duration of about 28 hours. The trajectory has the form of a wool ball with more transparent threads in the periphery. The black spot marking a tempo vicinity of 55 bpm and 15 sone seems to be a kind of "gravity center" for the performance. In total, the entire performance shows that tempo and loudness vary independently: faster does not mean louder. Over most of the performance loudness varies between 10 and 15 sone, except a loudness peak up to 35 sone, and tempo varies between 45 and 65 bpm.

To summarise, we can say that the trajectory shown in Figure 8 corresponds well to the perceived overall impression of "Vexations" as an inexpressive composition with no clear climax. The repetition, which is its main feature, is represented in the small variation of loudness and a higher variation in tempo. In the trajectory, these findings correspond to the small surface covered by the trajectory's trace. However, we would like to emphasise that the interpretation of the trajectory in terms of "smallness" is only of descriptive value at the current state of research.

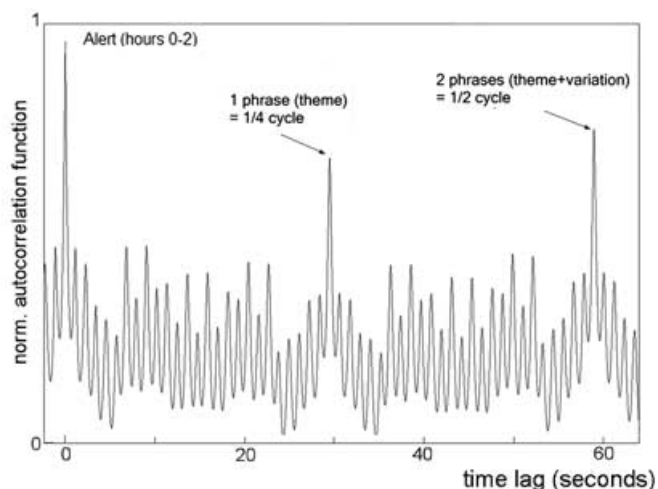

Fig. 9. Autocorrelation function of the loudness time series, for the alert state (0.00–9.00 hours). Periodical similarities of the pattern can be seen at multiples of about 60 and 120 seconds, which resembles one half and one full cycle of the piece at the actual performance speed. The hyperfine structure is produced by the sequence of the singular notes of each cycle.

Linear time series analyses of note durations and loudness

Figure 9 depicts the autocorrelation function of the loudness time series (in *sones*) for the state of alertness reported by the pianist (verified by the EEG data, see Kohlmetz et al., in press). The picket-fence-like hyperfine structure is produced by the repetition of eighth notes throughout the performance creating a period length of 1.15sec (the reciprocal of 52bpm). Mid-scale periodical similarities of the pattern can be seen at multiples of about 60 and 120 seconds, which unsurprisingly resembles one half and one full cycle of the piece at the actual performance speed. However, the larger time scale shown in Figure 10 reveals a slow periodicity with a period of 600 seconds (10 minutes or 5 full cycles, respectively). This slow periodicity in the loudness time series might be due to physiological ultradian oscillations and will be discussed below in detail.

Non-linear time series analyses of note durations and loudness

Correlation dimension

In Figures 11 and 12, the correlation dimension is plotted versus ϵ for different embedding dimensions m ranging from 1 to 72. In each case, asymptotic behavior reaches saturation for $m \approx 18$.

The graphs do not exhibit a clear plateau or saddle; therefore the actual value of the correlation dimension for $m > 18$ can only be estimated. For the IOI data, the correlation dimension increases from 0.3 to 1.2 with decreasing vigilance (alert \rightarrow drowsy $>$ trance, see Fig. 11). For the loudness data, a similar trend can be observed: the correlation

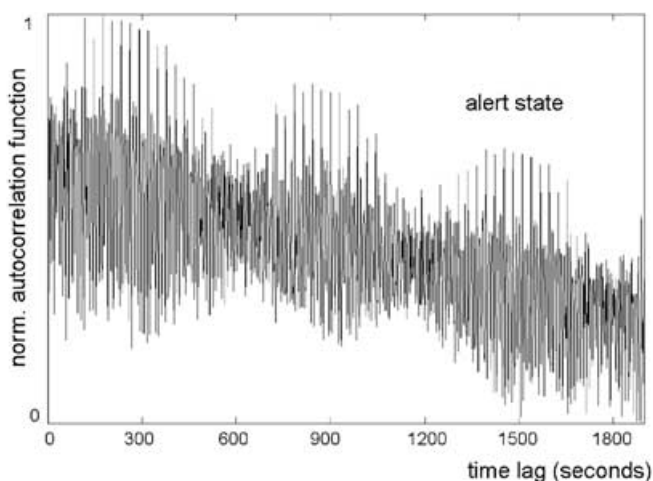

Fig. 10. Larger scale image of Figure 9. In addition to the fine structure, a slow periodicity with a period of 600 seconds (10 minutes or 5 full cycles, respectively) becomes evident.

dimension increases from 5.5 to 14 with decreasing vigilance (see Fig. 12).

Lyapunov exponents

However, the *sones* note onset data revealed a considerable linear part, which is shown in Figure 13. A Lyapunov coefficient could be estimated for all conditions. As with the correlation dimension, a steady trend can be observed that correlates with the overall state of alertness (cf. protocol and EEG data). λ increases from an initial value of 0.025 to 0.036 as vigilance declines from alertness to deep trance. A summary of the nonlinear estimation is given in Table 2.

Discussion

Straight-forward procedure of IOI analysis

The application of a simple straight-forward procedure for the analysis of note durations was only a pragmatic method developed for the specific features of the “Vexations” data. An exact matching of score to performance events would have been possible. However, due to omnipresent variation in data (such as omitted notes, variation of tempo, wrong notes etc.) this matching would always need manual correction and thus would be extremely time-consuming. This also means that the IOI categorisation should only be applied to the analysis of more complex scores, if the number of different note durations is not too high. Otherwise IOIs with only a small difference would fall through the net of this IOI categorisation procedure.

Tempo and loudness analysis

Data analysis started with the analysis of tempo changes over the entire performance duration. The main finding of this first

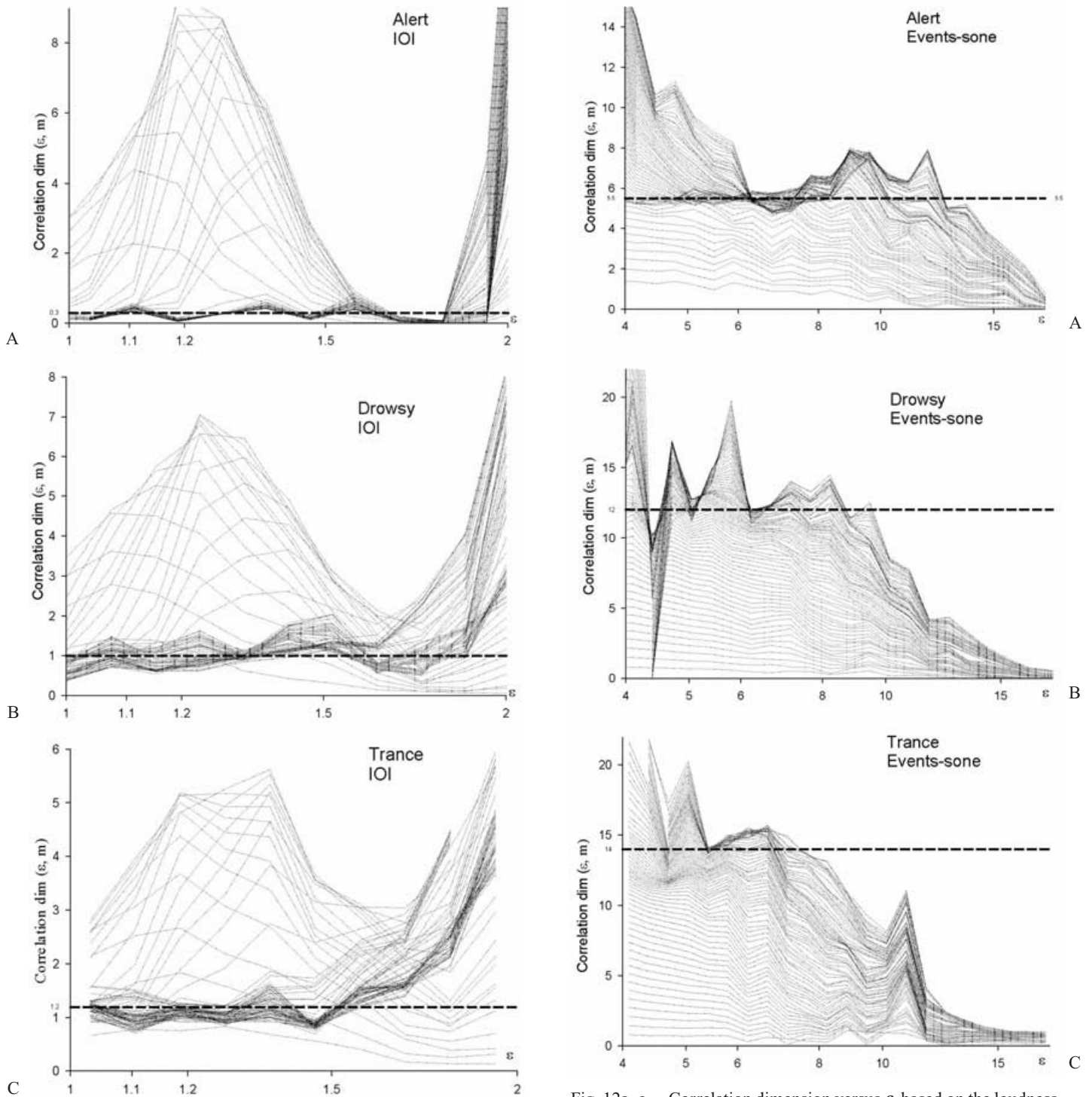

Fig. 11a–c. Correlation dimension versus ϵ , based on the IOI data of different states of consciousness. Correlation dimension ϵ is a measure of the structural complexity of an attractor. The set of curves is produced by varying the embedding dimension m from 1 to 72. Alert (upper panel): asymptotic behavior reaches saturation for $m > 18$, yielding a correlation dimension of 0.3; drowsy (middle panel): asymptotic behavior reaches saturation for $m > 18$, yielding a correlation dimension of 1.0; trance (lower panel): asymptotic behavior reaches saturation for $m > 18$, yielding a correlation dimension of 1.2.

Fig. 12a–c. Correlation dimension versus ϵ , based on the loudness data (sone) of different states of consciousness. Correlation dimension ϵ is a measure of the structural complexity of an attractor. The set of curves is produced by varying the embedding dimension m from 1 to 72. Alert (upper panel): asymptotic behavior reaches saturation for $m > 18$, yielding a correlation dimension of 5.5; drowsy (middle panel): asymptotic behavior reaches saturation for $m > 18$, yielding a correlation dimension of 12; trance (lower panel): asymptotic behavior reaches saturation for $m > 18$, yielding a correlation dimension of 14.

analytical step was the high degree of mean tempo stability over a long period of time (about 14 hours). As Figure 4 shows, at the end of this phase of alertness, instability increased by an acceleration of tempo and remained unstable during the phase of trance. The initial tempo stability could not be re-established by the player in the third “drowsy” section. As an overall tendency, note durations remained surprisingly constant with a standard deviation of less than 10% for eighth notes and quarter notes. Only dotted quarter notes with a duration longer than 2.9s were characterised by a standard deviation of 33%. This finding is in accordance with results from experiments on isochronous serial interval production. As Madison (2000) reports, a standard deviation between 3 and 6% of the IOI is typical for IOIs up to two seconds. Even with extensive training, musicians show an IOI deviation of 2.8% for IOIs of 300 ms. This tempo variability is determined by central nervous processes, such as the individual tempo discrimination threshold, as well as the peripheral motor delay of fingers and hands (Wing & Kristofferson, 1973). Generally, tempo stability depends on IOI duration and decreases with increasing IOIs, corresponding with decreasing tempo (for an overview see Madison, 2000). With this in mind, the performer played with an extraordinary stability as regards mean tempo. It remains uncertain as to why no general tempo drift (such as a con-

tinuous slowing down in slow tempo) occurred in the first 14 hours of performance, as would have been expected according to findings in continuation experiments with tapping. Up until now it is inconclusive as to whether highly trained musicians are able to compensate for error in timing, and can thus avoid general tempo drifts instead of error cumulation. For example, Clynes and Walker (1982) found that tempo drift in the tapping of isochronous intervals disappeared when tapping to the pulse of an imagined Mozart piano concerto. The subject showed a remarkable mean IOI duration of 0.511 s with a SD of 0.0026 s during 4000 taps. Additionally, results from the measurement of repeated performances of Bach’s Goldberg Variations by one pianist over more than one decade (Clynes & Walker, 1982) showed a surprisingly high degree of duration stability for the single variations. Following on from this, it cannot be excluded that the tempo stability of a musical performance is influenced by psychomotoric “noise” and drift on a more local level. However, at a global level, the duration of an entire movement is stored and coded in a different memory system and could work as an overall error compensation mechanism.

The analysis of the loudness curve over the entire performance showed a surprising result: over more than 18 hours a continuous decline of loudness can be observed. Technical reasons for this decline can be excluded.¹ This tendency is resumed after the sudden eruption of loudness at the end of the trance section at $t = 19$ hours, and continues for the rest of the performance. Up until now there has been no report on a decrescendo over such a long period of time. The comparison between the courses of loudness and tempo reveals an interesting result: during the trance section instability occurs firstly in tempo. This phenomenon is interpreted as an asynchrony of parameter control in musical performance. Tempo seems to be more sensitive to a loss of control (caused by the state of trance) than loudness, and as Figure 7 reveals, control of loudness can be stabilised even when the performer is in a state of extreme drowsiness. This desynchronisation of performance parameter stability has been described here for the first time. The relative independence of changes in tempo and loudness can also be observed in

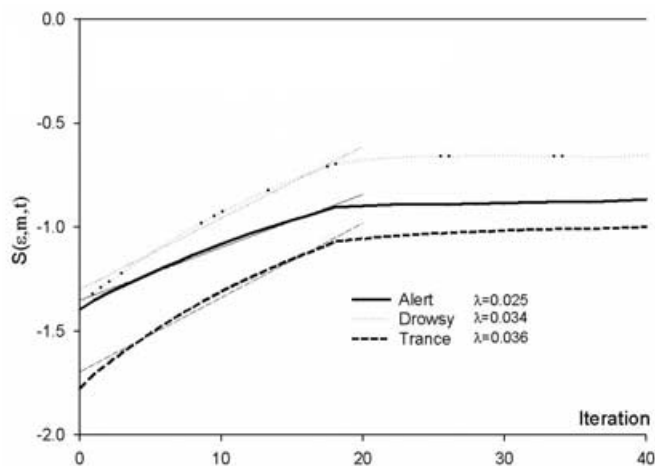

Fig. 13. Estimation of the maximum Lyapunov coefficient (based on event succession of onsets) by regression of the linear part of the $S(\epsilon, m, t)$ -plot and determining the slope of the fit. Embedding dimension: $m = 18$, delay $d = 1$.

¹Note: Data sheets of microphones and mixing console gave no indication of instability of phantom power or electrical charge over time. Temperature-dependency of microphone sound pressure sensitivity can also be excluded. High degree of electrical stability was confirmed by the manufacturer.

Table 2. Summary of embedding dimension, correlation dimension, and Lyapunov coefficient.

Subject's state	d [hours]	Embedding dimension	Correlation dimension (IOI)	Correlation dimension (sone)	Lyapunov coefficient (sone)
Alertness	0.00–9.00	18	0.3	(5.5)	+0.025
Drowsiness	19.00–21.00	18	1.0	(12)	+0.034
Trance	14.00–19.00	18	1.2	(14)	+0.036

the trajectory of Figure 8. An assumed coupling of performance parameters (such as "the faster, the louder") would result in a diagonal trajectory. However, Figure 8 clearly displays that tempo and loudness are controlled independently.

Time series analysis

The evaluation of the autocorrelation function, in addition to revealing note repetition periodicities and phrase repetition periodicities, shed light on performance oscillations at larger time scales. These oscillations have possibly physiological sources and are superimposed onto the piano performance with rather feeble amplitudes. To highlight these weak performance oscillations, a very large number of coherent samples (over a long time series) is needed. The performance of "Vexations" provides a unique model that allows for such novel large-scale performance analyses.

The goal of the non-linear approach was to address the question as to whether those large-scale performance fluctuations are basically random, or rather highly complex yet deterministic. The embedding procedure clearly suggests that the correlation dimension does not increase beyond a certain value as the embedding dimension is increased. From this, an underlying structure of the performance can be inferred, which is complex enough to require an unfolding of at least 18 dimensions. The dimensionality of $n = 18$ fits perfectly into the properties of the piece, since a single repetition of the phrase (theme, or one of the variations, respectively) consists of 18 notes. In other words, if one assigns an independent coordinate of an 18-dimensional space to each individual event of the theme – i.e., one single point in that space contains all the information on the performance of one full theme/variation – then a complex trajectory unfolds that cannot be sufficiently displayed in less than those 18 dimensions.

The correlation dimension gives an idea as to how complex a possible attractor should be. If the correlation dimension does not converge, the irregularity is produced by noise. However, the mere fact that the correlation dimension converges, suggests that the underlying dynamical process is a deterministic chaos, rather than just noise. With regard to this chaos, the notion of the 18-dimensional trajectory as a possible attractor should be addressed. Naturally, the performance of the piece is highly constrained by the composition itself, and at least with respect to timing (IOIs), subsequent repetitions of the theme force the player to perform similar motor movements over and over again. The composition does not allow the performer to leave this fixed frame. Yet, the estimation of the Lyapunov exponent suggests a rather different phenomenon. A positive value of the Lyapunov coefficient means that for very similar initial conditions, the resembling future phase states tend to drift apart; the larger λ , the faster the tempo. Thus, a positive λ is a sign of irregularity of the time series. As mentioned above, the constraints of the composition suggest a highly converging performance over time. However, the estimated Lyapunov coefficients are small but

positive. Together with the saturation of the correlation dimension (suggesting complex deterministic behavior), this finding points towards the presence of a "performance generator" which exhibits characteristics of a deterministic chaos.

In our case, as customary with measured data, the picture seems to be somewhat ambiguous, suggesting that noise as well as a trace of a high-dimensional chaotic component contributes to the shaping of tempo and loudness in the performance of "Vexations."

Vigilance, periodic changes and endogenous rhythms

The most remarkable feature of tempo and loudness analysis is a de-synchronised and increasing degree of instability over the first 19 hours of performance. An initial explanation for this drift could be made by referring to changes in vigilance as a confounding variable. However, a research of the literature of the influence of vigilance on the long-term estimation of loudness or time duration showed no results. We have serious doubts as to whether there can be a direct influence of psychophysiological activation on performance at all. An indirect effect on performance data could be assumed by a shift of perceptual thresholds through changes in vigilance. Even the assumption of indirect effects of vigilance on performance implies an insolvable methodological problem in the determination of perceptual thresholds: as such thresholds can only be measured by a subject's reaction or performance, it is impossible to separate performance from compensational neuropsychological mechanisms. This view is supported by findings from experiments in occupational medicine. As Galley (1998) demonstrates in an experiment on the relationship between saccadic activation and performance, subjects show no decrease in ability in an eye-tracking task when activation was reduced after intake of benzodiazepine. Due to compensational neuropsychological mechanisms of task adaptation, performance seems to be practically independent of changing activation.

In addition to the assumption of a "performance generator," the underlying psychophysiological foundations of periodic changes in tempo and loudness should be examined. Our finding of periodic changes in tempo and loudness (see Figs. 9 and 10), within time frames of up to 30 minutes, remains a challenge for performance research. Let us bear in mind: up until now, there has been no performance research that would support the assumption of a conscious and intentional process as an explanation for the observed shaping of tempo and loudness within those large time frames. Thus, it would be speculative to interpret these changes in terms of an intentional or voluntary musical interpretation. As an alternative explanation for the observed periodic changes in loudness and tempo, we will look at underlying endogenous periodic processes, which could influence motor performance in the following section. This explanation is based on the fundamental assumption of Birbaumer and Schmidt (1999) who postulate that all body functions are shaped by

periodic changes. Mental performance (such as in memory tasks) is synchronised with body temperature amongst other factors. The authors show that the suprachiasmatic nucleus plays the role of a central ultradian pacemaker which coordinates numerous oscillators with different periodicities such as body temperature, level of growth hormone, level of cortisol, or pain threshold.

Since the discovery of the “basic rest-activity cycle” (BRAC) by Kleitman (1967), an influence of ultradian rhythms (with periodicities smaller than 20 hours) on basic vital functions, such as motor performance and sensory acuity has become widely accepted. BRAC means a change of intensity in low frequency brain waves during sleep with a periodicity of 90 minutes. In a review study representing the state of BRAC research of the late 1970s, Kleitman (1982) found much evidence for the existence of endogenous rhythms. A short review of the current state of research on the relationship between ultradian rhythms and psychomotor performance can be sorted by the size of time frame affected:

40 seconds to 30 minutes

Makeig and Inlow (1993) measured the coherence of slow mean variations in EEG power and in local error rate in an acoustic target detection task. A significant coherence between many EEG frequencies and task performance with cycles of 4 min and 90 s is shown. Conte, Ferlazzo, and Renzi (1995) investigated whether reaction time to an acoustic stimulus is influenced by individual performance rhythms. The authors showed that attention capacity changed with periods ranging from 5 to 30 minutes.

0.5 to 2.5 hours

Investigations of periodicity within a time frame of 90 min BRAC show an ambiguous picture. In order to study the relationship between body temperature and reaction time, Almirall, Ferrer, and Sanchez-Turet (1988) measured the performance in a reaction time task over a period of 5 hours. Time series analysis did not show an ultradian cyclicity of 90 min. Hayashi, Sato, and Hori (1994) studied ultradian rhythms in task performance and EEG activity over a period of 9 hours. Spectral analysis of behavioral data revealed a cyclicity of 2 hours, and analysis of EEG data showed a slower component (with a periodicity of 4 hours) and a faster component (with a periodicity of 1.3 to 2.4 hours). Grau et al. (1995) investigated ultradian rhythms in human gross motor activity and recorded the frequency of motor activity in a monotonous environment over 5 hours. Rhythmometric analysis showed activity rhythms with periods between 0.5 and 2.5 hours. Due to the analysis of ultradian rhythms in cognitive functions, the study by Gordon, Stoffer, and Lee (1995) is of special interest. The authors measured the performance of cognitive tasks (such as verbal, spatial and perceptual speed tests) over a period of 8 hours. Additionally, blood samples were taken. Results showed multiple cycles

with a periodicity of 80 minutes for the verbal task, and of 96 minutes for the spatial task. Luteinizing hormone had a period of 120 minutes. The authors conclude that cognitive task performance is associated with endogenous neurochemical systems. However, Neubauer and Freudenthaler (1995) investigated ultradian rhythms in cognitive performance and found no significant 90-min periodicity. The authors are critical of the earlier BRAC studies due to a lack of conservatism in statistical methods.

2.5 to 20 hours

Studies of long-term performances are rare. However, two studies reveal interesting insights into the role of endogenous rhythms on human performance. Miller (1995) collected 10,000 hours of EEG and behavioral data from commercial truck drivers, driving runs of 10 to 13 hours. Typed into a database this immense collection is now available for all researchers interested in long-term psychophysiological and performance data. Up until now there has been nothing comparable in music performance. In a longitudinal study Nakano et al. (2000) measured the psychomotor performance and physiological data during 19 hour sleep deprivation. Periodicities of physiological indicators (heart rate, body temperature, etc.) differed significantly and influenced the degree of errors.

General discussion

In summary, we can conclude that up until now, very little has been established about the influence of circadian rhythms on musical performance. However, the analysis of tempo and loudness fluctuations shows that an influence of endogenous processes on the long-term shaping of expressive parameters cannot be denied. The recording of “Vexations” is a first step in the collection of long-term performance data, however, the “Vexations” project investigates an extreme case of musical performance. In a more normal case the main interest of performance research focuses on performance durations of between five minutes and one hour. With this background it is clear that “Vexations” is an exploration into a thus far unknown territory. However, the analysis demonstrates that it is possible to develop and apply linear as well as non-linear analytical tools for the analysis of extremely long performances. It becomes clear that these tools must fit the specific needs of the performed composition. This calls for further development of adequate analytical tools in future research. Another interesting examination would be the comparison of the composition played by different performers in order to reveal the similarities as well as differences among the artists. For example, would other performers keep the same steady tempo over 13 hours? The pianist who took part in our project was well prepared and experienced in long-term performances. Thus, we cannot be sure whether his psychophysiological behavior is unique. Other performers could

experience different sequences in their altering states of consciousness.

Our findings also contribute to the understanding of complex artistic processes. We could clearly show that the highly repetitive and simple structure of "Vexations" does not result in a corresponding interpretation of low complexity. Non-linear methods revealed that changes in loudness and tempo are of a highly complex nature, and both parameters unfold in an 18-dimensional space. This has never before been demonstrated in performance research. Although we did not expect to generalise our analytical tools, we would like to state that our method of dimensional analysis is independent from the performance duration and thus can also be applied to much shorter compositions. The use of tempo-loudness trajectories has been a further promising way for the analysis of performance features over the unfolding of time within a performance. The advantage of this method is that it reveals the complex interaction between the performer's shaping of tempo and loudness and is also independent of the performance's duration. We would also like to emphasise that this integration of performance parameters into clearly structured visualisations corresponds to the listeners' subjectively perceived auditory sensation of a performance, and we predict that the visualisation of performance data will be a central point in further progress of performance research.

In conclusion: linear and non-linear methods, the integration of performance data in easily understandable visualisations and the comprehension of the role of underlying psycho-physiological processes are predicted as being the most promising ways for an adequate understanding of a musical performance's idiosyncrasies. In this respect, the "Vexations" project is a first step in a new direction.

Acknowledgements

This project could not have been realised without the help of numerous people. We are indebted to the support of the following people: Armin Fuchs (Würzburg), Christine Kohlmetz, Christian Wolf, Michael Großbach, Timo Weggen, Wolfgang Trappe, Matthias Harnitz, Annika Hempel (Hanover), Simon Dixon (Vienna), and Jörg Langner (Berlin). The project was funded by the Hanover University of Music and Drama, Yamaha Europe Corp. and the Cultural Foundation of Saxony. The recording took place in the Societaetstheater, Dresden, Germany, on May 20 and 21, 2000. The pianist was Armin Fuchs.

Performance data and software used for data analysis can be obtained from the website <http://musicweb.hmt-hannover.de/satie>.

References

Alexander, C.N., Davies, J.L., & Dixon, C.A. (1990). Growth of higher states of consciousness: Maharishi's Vedic psychology

of human development. In: C.N. Alexander, & E.J. Langer (Eds.), *Higher stages of human development: perspective on adult growth* (pp. 286–341). New York: Oxford University Press.

- Almirall, H., Ferrer, R., & Sanchez-Turet, M. (1988). External auditory canal temperature and reaction time relationship during long performances. *International Journal of Psychophysiology*, 6, 215–220.
- Birbaumer, N., & Schmidt, R.F. (1999). *Biologische Psychologie* (4th ed.). Berlin: Springer.
- Bryars, G. (1983). "Vexations" and its performers. *Contact*, 26, 12–20.
- Cage, J. (2001). *ORGAN/ASLSP – John Cage in Halberstadt*. Retrieved, from the World Wide Web: <http://www.john-cage.halberstadt.de>
- Clarke, E.F. (1982). Timing in the performance of Erik Satie's "Vexations." *Acta Psychologica*, 50, 1–19.
- Clynes, M., & Walker, J. (1982). Neurobiologic functions of rhythm, time, and pulse in music. In: M. Clynes (Ed.), *Music, mind, and brain. The neuropsychology of music*. New York: Plenum Press.
- Conte, S., Ferlazzo, F., & Renzi, P. (1995). Ultradian rhythms of reaction times in performance in vigilance tasks. *Biological Psychology*, 39, 159–172.
- Dunn, B.R., Hartigan, J.A., & Mikulas, W.L. (1999). Concentration and mindfulness meditations: Unique forms of consciousness? *Applied Psychophysiology and Biofeedback*, 24, 147–165.
- Eckmann, J.-P., & Ruelle, D. (1985). Ergodic theory of chaos and strange attractors. *Review of Modern Physics*, 57, 617–656.
- Galley, N. (1998). An enquiry into the relationship between activation and performance using saccadic eye movement parameters. *Ergonomics*, 41, 698–720.
- Gordon, H.W., Stoffer, D.S., & Lee, P.A. (1995). Ultradian rhythms in performance on tests of specialized cognitive function. *International Journal of Neuroscience*, 83, 199–211.
- Grassberger, P., & Procaccia, I. (1983). Measuring the strangeness of strange attractors. *Physica D*, 9, 189–208.
- Grau, C., Escara, C., Cilveti, R., Garcia, M., Mojon, A., Fernandez, J.R., & Hermida, R.C. (1995). Ultradian rhythms in gross motor activity of adult humans. *Physiological Behavior*, 57, 411–419.
- Hayashi, M., Sato, K., & Hori, T. (1994). Ultradian rhythms in task performance, self-evaluation, and EEG activity. *Perceptual & Motor Skills*, 79, 791–800.
- Hegger, R., Kantz, H., & Schreiber, T. (1999). Practical implementation of nonlinear time series methods: The TISEAN package. *Chaos*, 9, 413–435.
- Jevning, R., Wallace, R.K., & Beidebach, M. (1992). The physiology of meditation: A review. A wakeful hypometabolic integrated response. *Neuroscience & Biobehavioral Reviews*, 16, 415–424.
- Kleitman, N. (1967). The basic rest-activity cycle and physiological correlates of dreaming. *Experimental Neurology, Suppl 4*, 2–3.

- Kleitman, N. (1982). Basic rest-activity cycle-22 years later. *Sleep: Journal of Sleep Research & Sleep Medicine*, 5, 311–317.
- Kohlmetz, C., Kopiez, R., & Altenmüller, E. (2003). Stability of motor programs during a state of meditation: Electro-cortical activity in a pianist playing “Vexations” by Erik Satie continuously for 28 hours. *Psychology of Music*, 31, 173–186.
- Kopiez, R. (1998). Die Performance von Erik Saties Vexations aus Pianistensicht. In: R. Kopiez, B. Barthelmes, H. Gembris, J. Kloppenburg, H. von Loesch, H. Neuhoff, G. Rötter, & C.M. Schmidt (Eds.), *Musikwissenschaft zwischen Kunst, Ästhetik und Experiment. Festschrift Helga de la Motte-Haber zum 60. Geburtstag* (pp. 303–311). Würzburg: Königshausen & Neumann.
- Langner, J. (2002). *Musikalischer Rhythmus und Oszillation. Eine theoretische und empirische Erkundung*. Frankfurt a. M.: Peter Lang.
- Langner, J., & Goebel, W. (2002). *Representing expressive performance in tempo-loudness space*. Proceedings of the 10th Anniversary conference of the European Society for the Cognitive Sciences of Music. Liège, 5–8 April, CD-ROM.
- Langner, J., & Goebel, W. (in press). Visualizing expressive performance in tempo-loudness space. *Computer Music Journal*.
- Langner, J., & Kopiez, R. (1996). Entwurf einer neuen Methode der Performanceanalyse auf Grundlage einer Theorie oszillierender Systeme. In: K.-E. Behne, H. de la Motte-Haber, & G. Kleinen (Eds.), *Jahrbuch Musikpsychologie* (12, pp. 9–27). Wilhelmshaven: Noetzel.
- Langner, J., Kopiez, R., & Feiten, B. (1998). Perception and representation of multiple tempo hierarchies in musical performance and composition. In: R. Kopiez, & W. Auhagen (Eds.), *Controlling creative processes in music* (pp. 13–35). Frankfurt: Peter Lang.
- Madison, G. (2000). On the nature of variability in isochronous serial interval production. In: P. Desain, & L. Windsor (Eds.), *Rhythm. Perception and production* (pp. 95–113). Lisse: Swets & Zeitlinger.
- Makeig, S., & Inlow, M. (1993). Lapses in alertness: Coherence of fluctuations in performance and EEG spectrum. *Electroencephalography & Clinical Neurophysiology*, 86, 23–35.
- Mason, L.I., Alexander, C.N., Travis, F.T., Marsh, G., Orme-Johnson, D.W., Gackenbach, J., Mason, D.C., Rainforth, M., & Walton, K.G. (1997). Electrophysiological correlates of higher states of consciousness during sleep in long-term practitioners of the Transcendental Meditation program. *Sleep: Journal of Sleep Research & Sleep Medicine*, 20, 102–110.
- Michon, J.A. (1974). Programs and “programs” for sequential patterns in motor behavior. *Brain Research*, 71, 413–424.
- Miller, J.C. (1995). Batch processing of 10000h of truck driver EEG data. *Biological Psychology*, 40, 209–222.
- Nakano, T., Araki, K., Michimori, A., Inbe, H., Hagiwara, H., & Koyama, E. (2000). Temporal order of sleepiness, performance and physiological indices during 19-h sleep deprivation. *Psychiatry and Clinical Neuroscience*, 54, 280–282.
- Neubauer, A., & Freudenthaler, H.H. (1995). Ultradian rhythms in cognitive performance: No evidence for a 1.5-h rhythm. *Biological Psychology*, 40, 281–298.
- Orledge, R. (1992). *Satie the composer*. Cambridge: Cambridge University Press.
- Rosenstein, M.T., Collins, J.J., & De Luca, C.J. (1993). A practical method for calculating largest Lyapunov exponents from small data sets. *Physica D*, 65, 117–134.
- Satie, E. (1988). *Schriften*. Hofheim: Wolke.
- Theiler, J. (1990). Estimating fractal dimension. *Journal of the Optometric Society of America A*, 7, 1055.
- Travis, F., & Pearson, C. (1999). Pure consciousness: distinct phenomenological and physiological correlates of “consciousness itself.” *International Journal of Neuroscience*, 100, 77–89.
- Wehmeyer, G. (1998). *Erik Satie*. Reinbek: Rowohlt.
- West, M.A. (1980). Meditation and the EEG. *Psychological Medicine*, 10, 369–375.
- Wing, A.M., & Kristofferson, A. (1973). Response delays and the timing of discrete motor responses. *Perception & Psychophysics*, 13, 455–460.
- Zwicker, E., & Fastl, H. (1999). *Psychoacoustics. Facts and models* (2nd ed.). Berlin: Springer.